

Model V-650F

OSCILLOSCOPE

OPERATION MANUAL



HITACHI
Hitachi Denshi, Ltd.

CONTENTS

	Page
1. Features.....	1
2. Composition.....	1
3. Precautions.....	2
4. Names of Controls.....	6
5. How to Produce the Bright Line.....	8
6. Method for Connecting Signals.....	10
7. Measuring Procedure.....	13
(1) DC voltage measurement.....	13
(2) AC voltage measurement.....	13
(3) Measurement of frequency and period.....	14
(4) Measurement of time difference.....	14
(5) Measurement of rise (fall) time.....	15
(6) Measurement of single-shot signal.....	16
(7) Synchronization of complexed waveform.....	16
(8) How to use TV exclusive synchronization.....	17
(9) Operating procedure of delayed sweep.....	19
(10) How to use TRIPLE.....	23
8. Panel Descriptions.....	24
(1) Power Supply and CRT	24
(2) Controls concerned with vertical axis.....	25
(3) Controls concerned with horizontal axis.....	27
(4) A synchronization.....	29
(5) B synchronization.....	32
(6) Miscellaneous.....	32
9. Standards and Specifications.....	33
10. Schematic Diagrams	37

1. Features

The Hitachi Model V-650F oscilloscope is a portable-type, advanced-class oscilloscope with a bandwidth of DC to 60MHz. Designed by putting special emphasis on operability and ruggedness, this oscilloscope has the following features:

- (1) Wide bandwidth:
The instrument has a bandwidth of DC to 60MHz.
- (2) High sensitivity:
Sensitivity is 1 mV/div.
- (3) Large 6" screen:
Employment of a large square CRT makes waveforms easier to observe.
- (4) Internal graticule:
Employment of internal graticule CRT permits waveforms observation to be made without parallax error.
- (5) Triple trace mode:
Since the triggering signal can be observed on the CRT screen, the phase difference between CH1 and CH2 input signals against external synchronizing signal can be measured.
- (6) TV synchronization:
Employment of a new TV sync/separator circuit allows instrument to observe TV signals stably.

- (7) Delayed sweep:
A portion of the signal can be magnified before observation.
- (8) Autofocus:
Focussing shift is automatically corrected.

2. Composition

Composition of Model V-650F oscilloscope is as follows.

- (1) Model V-650F oscilloscope unit..... 1
- (2) Probe (AT-10 AD 1.5)..... 2
- (3) Fuse (2A for 100V and 120V set
or 1A for 220V set and 240V set)... 1
- (4) Dust proof cover..... 1
- (5) Power supply cord..... 1
- (6) Operation manual..... 1

3. Precautions

Precautions to be observed to lengthen the service life of this instrument.

Installation site

- * Avoid installing instrument in an extremely hot or cold place.
 - o Avoid placing this instrument in a place exposed to sunlight for a long period of time, in a closed car in midsummer, or near a room heating device such as a stove.
 - o The operating maximum ambient temperature is +50°C.
- * Do not use instrument that has been left outdoors on a cold winter day.
The operating ambient temperature is 0°C or more.
- * Avoid moving the instrument rapidly from a hot place to a cold place or vice versa, or condensation may form on inside of the instrument.
- * Keep the instrument away from damp air, water, and dust. Unexpected trouble may be caused when the instrument is placed in a damp or dusty place. The operating ambient humidity is 35 ~ 85%. Since an accidental intrusion of water may also cause troubles, do not place a water-filled con-

tainers such as a vase on the oscilloscope.

- * Do not place the instrument in a place where vibration is strong. Avoid using the instrument at a place vibrating violently. Since the oscilloscope is a precision instrument, excessively strong vibrations may cause damage.
- * Do not place the instrument near a magnet or magnetic body. An oscilloscope is an equipment using electron beam. Therefore, do not bring a magnet close to the instrument or do not use the instrument near an equipment generating strong magnetic force.

Handling

- * Do not put a heavy objects on the oscilloscope. Do not block the ventilation holes.
- * Do not apply a heavy shock to the oscilloscope.
- * Do not insert a wire, pin, etc. through the ventilation hole.
- * Do not drag the set, leaving the probe attached to it.
- * Do not leave a hot soldering iron on the cabinet or the screen.
- * Do not try to turn the instrument upside down. Otherwise, knobs may be broken.

- * Do not use the instrument upright, leaving BNC cable connected to EXT BLANKING terminal on the rear panel. Otherwise, the cable may be damaged.

When not in use

- * When not in use, put the dust-proof cover on the instrument and store it with care.

When Operation is faulty.

Recheck the operating procedure and if problem persists, contact a nearby service station or agent.

Care and Repair

- * Removal of stain from the case.
 - o When the outside of the case is stained, remove the stain by first wiping it lightly with a cloth moistened with neutral washing agent and then wipe the surface with a dry cloth.
- * Never use strongly volatile agent such as benzene and thinner.
 - o When the panel surface is stained, remove the stain in similar way with a clean, soft cloth. When heavy stains are present, first remove the stains by wiping the surface lightly with a cloth moistened with diluted neutral washing

agent or with alcohol and then wipe thoroughly with a dry cloth.

- o When dust has accumulated on the inside, remove it by using dry brush, or by using the exhaust of a compressor or a vacuum cleaner.

NOTE: When opening the case, pull out the power supply plug beforehand without fail.

When cleaning the inside, insure beforehand that no electricity remains in the condensers of the power supply circuit.

- * Cleaning of CRT

Dirty surface of CRT screen tends to cause measuring errors. The screen surface becomes visible when the scum at each of the 4 corners of the bezel is removed.

Remove the stains on CRT and filter by using a clean and soft cloth, paying attention not to impair them.

When the stain is extremely heavy, wash them with neutral washing agent and then leave them stand until the moisture is removed naturally.

- o If the screen is installed while it is mois-

tened, water rings may be formed and the waveform may be blurred to become hard to observe. Pay attention not to leave finger prints on it.

Cautions to be observed before measurement

- * Check the line voltage.

The operating voltage range of this oscilloscope is as shown below. Check the line voltage with out fail before turning on the power switch.

Rating	Line Voltage (50/60Hz)
100V AC	90 - 110V AC
120V AC	108 - 132V AC
220V AC	198 - 242V AC
240V AC	216 - 264V AC

Nominal volts $\pm 5\%$ at 400Hz.

In the case of normal shipment, the voltage selector will be set convenient for user up. When it is intended to use the oscilloscope on voltages other rating, voltage selector can be turned. (Rated voltages are indicated on the rear panel of the oscilloscope.)

- * Use only specified fuses.

In order to protect the circuit against over-current, a 2A (make use of 100VAC or 120VAC) or

1A (make use of AC220V or AC240V) is used on the primary side of the power supply. When this fuse is below out, check thoroughly the cause. repair any faulty point present, and then replace with a specified fuse. Do not try to use the fuse other than the specified ones. Otherwise, fault may be caused or danger may be invited. (Particularly, do not use a fuse different from the specified one in current capacity and in length.) The standards if the fuses are as follows.

	Shape (Diameter × length)mm	JIS type name
2A	6.35 ϕ × 31.8	MF61NM250V 2A AC
1A	6.35 ϕ × 31.8	MF61NM250V 1A AC

- * Do not increase the brightness too much. Do not increase the brightness of the spot and trace too much. Your eyes may be strained and the fluorescent surface of CRT may be burnt.
- * Do not apply an excessive voltage. The input withstand voltage of each in put connector and probe input is as follows. Never apply a voltage higher than specified.

INPUT direct 250V(DC + AC peak at 1 kHz)
 When probe is used 500(DC + AC peak at 1 kHz)
EXT TRIG INPUT 250V(DC + AC peak)
EXT BLANKING 20V(DC + AC peak)

Calibration Interval

To maintain instrument accuracy, perform the calibration of the V-650F at least every 1000 hours of operation, or every six months if used infrequently.

4. Names of Controls

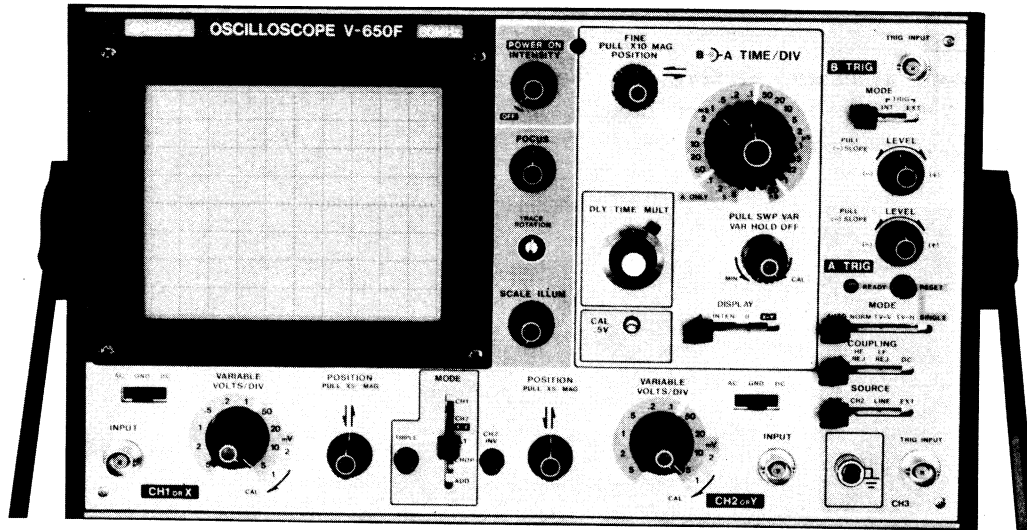

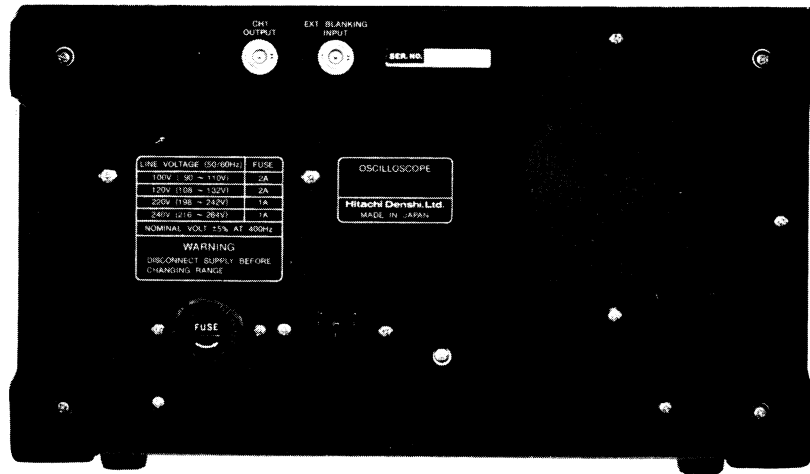

LINE VOLTAGE (50/60Hz)	FUSE
100V (50 ~ 110V)	5A
120V (110 ~ 132V)	2A
220V (110 ~ 240V)	1A
240V (210 ~ 264V)	1A
NOMINAL VOLT 55% AT 60Hz	

WARNING
DISCONNECT SUPPLY BEFORE
CHANGING FUSE.

OSCILLOSCOPE
Hitachi Denisha Ltd.
MADE IN JAPAN.

5. How to Produce the Bright Line

Unless handled erroneously, this instrument will never become faulty by ordinary operation.

Before turning ON the POWER switch, insure the power supply voltage is within the range of 108V - 132V for 120V AC set, 198V - 242V for 220V AC set, and 216V - 264V for 240V AC set. Refer to the indication on the rear panel of the instrument for other voltages.

Insert the plug of the power cord on the rear panel into the power supply wall socket and set the knobs as follows.

INTEN POWER	OFF
FOCUS	Center
AC - GND - DC	GND
↔ POSITION	Center (the knob is in the depressed state.)
A TRIG	AUTO
A TRIG COUPLING	AC
A TRIG SOURCE	CH1
A TIME/DIV	0.5 ms/DIV
B TIME/DIV	Arbitrary
DISPLAY	A
HOLD OFF	Counterclockwise to the full

↑↓ POSITION	Center (The knob is in the depressed state.)
MODE	CH1

Set all the levers of the switches either to the left side or to the upper side.

After ending all the settings mentioned above, turn ON the POWER and, 15 seconds later, rotate the INTEN knob clockwise. Then the sweep bright line will appear.

If observation is to be started immediately, set the FOCUS knob at a point where the bright line is sharpest.

If the instrument is not used with the power supply turned on, rotate the INTEN counterclockwise to reduce the brightness and also blur the FOCUS.

NOTE

For usual observation, leave the following non-calibrating function section set to "CAL" position.

VARIABLE	Rotate in the direction of arrow. In this case the VOLTS/DIV is calibrated to its indicating value.
PULL SWP VAR	Leave the knob in depressed state. In this case the A TIME/DIV is

calibrated to its indicating value.

Align the bright line with the horizontal scale line at the center of the screen by operating CH1 POSITION. In some cases the bright line may be oblique to the scale slightly by the effect of earth magnetism. In this case, bring the bright line until it lies on the horizontal scale line at the center of the screen by properly adjusting the semi-fixed variable resistor TRACE ROTATION on the front panel.

— General measurement —

(1) In the case of observing a single waveform.

Use CH1 or CH2 when not observing the phase difference between two waveforms or when engaging in a operation other than X-Y operation. Make the following settings when using CH1.

MODE Switch of Vertical Axis	CH1
MODE Switch of A TRIG	AUTO
A TRIG SOURCE	CH1

Under these settings almost all the repetitive signals of about 30 Hz or more applied to CH1 can be synchronized and observed by adjusting A TRIG LEVEL. Since the MODE of horizontal axis is at

AUTO position, the bright line appears even when no signal is present or when AC-GND-DC switch is at GND position. This means that the measurement of DC voltage can be measured. The following switching is needed when observing low frequency signals of about 30 Hz or less.

MODE of A TRIG	NORM
----------------	------

Synchronization can be effected by operating LEVER knob under this setting.

When using only CH2, use the instrument after making the following settings.

MODE Switch of Vertical Axis	CH2
A TRIG SOURCE	CH2

(2) When observing two waveforms

Observation of two waveforms can be made easily by setting the MODE switch of vertical axis to ALT or CHOP.

When observing two waveforms of high repetition frequencies set the MODE switch to ALT and, in the case of low frequencies, set it to CHOP.

When measuring the phase difference, measure after effecting synchronization with leading phase signal.

(3) When observing three waveforms.

Turn the TRIPLE switch ON (depressed state). Three waveforms and the synchronizing signals can be simultaneously observed. In this case leave the MODE switch of vertical axis set at ALT or CHOP.

(4) When observing waveform with X-Y.

Set the MODE switch of vertical axis to CH2 (X-Y) and DISPLAY switch to X-Y. Then the instrument works as an X-Y oscilloscope.

Each input is applied to the instrument as follows.

X-axis signal (horizontal axis signal)	CH1 INPUT
Y-axis signal (vertical axis signal)	CH2 INPUT

In this case leave the horizontal axis magnification switch (PULL-MAG \times 10 minor shaft knob) at depressed position.

6. Method for Connecting Signals

The first step of measurement is introduce the signal desired to measure to the oscilloscope properly. Do it with utmost care.

(1) When using a probe.

Use the attached probe, AT-10AD 1.5, when measuring a high frequency wave with high accuracy.

It should be noted, however, that since the input signal is attenuated by this probe to 1/10 before it is input to the oscilloscope the use of the probe is disadvantageous for low signals, and that at the same time the measuring range is extended by that amount for high signals.

< CAUTIONS >

- o Do not apply a signal which exceed 500 V (DC + AC peak at 1 kHz).
- o Bring the grounding point of the earth lead wire of the probe close to the point to be measured when measuring a rapid rising signal or a high frequency signal. Long earth lead wire may cause waveform distortions such as ringing and overshoot.

Connection of earth lead wire

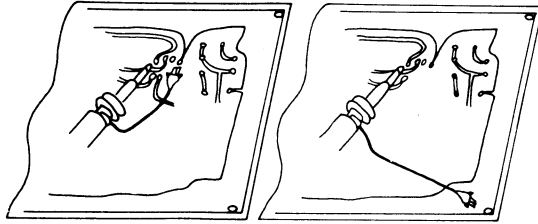

A good example

A bad example

For better measurement it is required to use an earth attachment available at option.

- o Multiply the reading of VOLTS/DIV by 10.

For example, if the VOLTS/DIV is 50mV/DIV, then read the waveform as

$$50\text{mV/DIV} \times 10 = 500\text{mV/DIV}$$

- o To avoid measurement error, put the probe in the following correction state and check it before measurement without fail.

Connect the tip of the probe to the output terminal CAL 0.5V of 1kHz calibration square wave voltage. When this correction capacity value is at optimum the waveform takes the shape as shown

in Fig. (a) as follows.

If the waveform is as shown in Fig.(b) or Fig.(c), rotate the semifixed adjusting screw on the matching box of the probe by using a screw driver until the optimum state is obtained.



(a) Optimum (b) Capacity too small (c) Capacity too large

- (2) At time of direct connection

When connecting a signal directly to the oscilloscope not using the attached probe AT-10AD 1.5 (10:1), pay attention to the following points in order to minimize the measurement error.

- o When performing observation using a bare lead wire, no trouble occurs of the circuit to be measured is of low impedance and high level. However, note that, in most cases, measurement error may be caused by static stray coupling with other circuit and power line. This measurement error cannot be ignored even in low frequency region.

In general, it is safe to avoid measuring with non-shielded connecting wire. When using a shielding wire connect one end of the shield to the earth terminal of the oscilloscope and the other end to the grounding of the circuit to be measured. It is desirable to use a coaxial cable with BNC type connector.

- o The following cautions must be observed when performing a wide hand measurement. It is necessary to terminate with the characteristic impedance of the cable when measuring a rapid rising waveform or a high frequency wave.

Especially when using a long cable, the absence of a terminating resistor will necessarily lead to a measurement error derived from ringing phenomenon. Some measuring circuits require a terminating resistor equal to the characteristic impedance of the cable also on the measurement terminal side.

BNC type terminating resistor (50 Ω) is conveniently used for this purpose.

- o In order to perform measurement with the measuring circuit put in proper operating state it is sometimes necessary to terminate the cable with

an impedance which corresponds to the circuit to be measured.

- o The stray capacity of the shield wire must be taken into account when performing measurement with a long shield wire. Since the shield wire normally in use has a capacity of about 100 pF per meter, its effect on the circuit to be measured cannot be ignored. Use a probe to minimize the effect on the circuit.
- o When the length of the shield wire used or when the length of the non-terminated cable reaches 1/4 wave length or its multiples within the band of V-650F type (1/4 wave length is about 1 meter when using a coaxial cable at 60 MHz), oscillation may be caused near 5 mV/DIV range. This is caused by the resonance between the externally connected high-Q inductance and the input capacity and can be avoided by reducing the Q. Connect the cable or shield wire to the input connector by way of a serially connected 100 Ω to 1 k Ω resistor, or perform measurement at other VOLT/DIV range.

7. Measuring Procedure

The first things to do are as follows.

- o Bring the brightness and FOCUS at optimum positions for easy read out.
- o Display the waveform as large as possible to minimize the read error.
- o Check the capacity correction when using a probe. (Refer to Paragraph (1) "When using a probe" of Section 6. "Method for connecting signal" for the method for correcting capacity.)

(1) DC voltage measurement

Set AC-GND-DC to GND and decide the zero level properly.

Set VOLTS/DIV appropriately and set AC-GND-DC to DC. Since the bright line shifts here by the amount of DC voltage, the DC voltage of the signal can be obtained by multiplying the shift width by the indicated value of VOLTS/DIV. When VOLTS/DIV is 50 mV/DIV, then $50 \text{ mV/DIV} \times 4.2 = 210\text{mV}$ (However, if the probe AT-10 AD 1.5 is in use, the true value of the signal becomes 10 times the value, or $50 \text{ mV/DIV} \times 4.2 \times 10 = 2.1\text{V}$.)

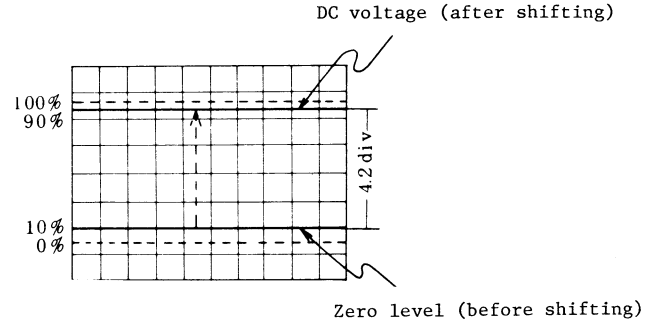

(2) AC voltage measurement

The same as paragraph 7 (1), "DC voltage measurement", but here there is no need of matching the zero level with the scale line. Move the zero level at will to a position easy to observe.

In the drawing as follows, VOLTS/DIV is 1V/DIV, $1\text{V/DIV} \times 5 = 5 \text{ Vp-p}$ (50Vp-p at time using the probe AT-10AD 1.5). When magnifying and observing a small-amplitude signal superimposing on a high DV voltage, set AC-GND-DC to AC. The DC voltage is cut off and AC voltage can be observed by increasing sensitivity.

$$1 \text{ ms/div} \times 2.0 = 2.0 \text{ ms}$$

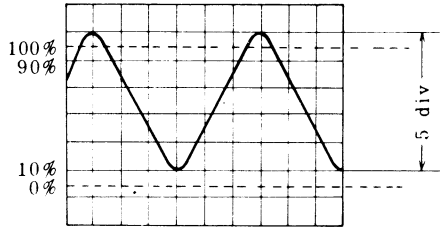

(3) Measurement of frequency and period

This will be explained taking the drawing at follows as an example

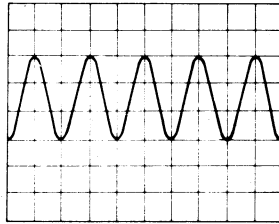

Time A Time B

One period covers the time A and time B, which are separated from each other by 2.0 DIV on the screen.

When the sweep time is 1ms/div, the period is given by

Accordingly, the frequency is

$$1/(2.0 \times 10^{-3}) = 500 \text{ Hz}$$

(However, when the knob MAG $\times 10$ is at pulled out position, TIME/DIV must be converted to 1/10 since the sweep is magnified.)

(4) Measurement of time difference

Triggering signal source "SOURCE" is selected as offering reference signal when measuring the time difference between two signals. Assume that pulse trains as shown in (a). Then (b) shows the case when CH1 is taken as the triggering signal source and (c) the case where CH2 is taken.

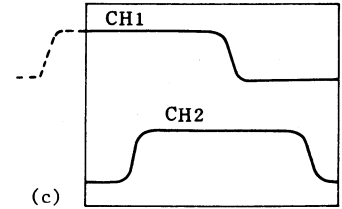
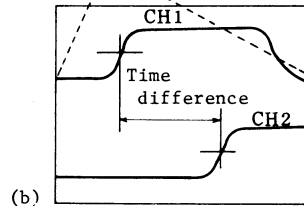
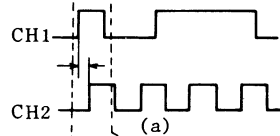

This means that CH1 is used as the triggering signal when investigating the length of time by which the signal of CH2 is delayed from the signal of CH1. CH2 is used in the reversed case. In other words, the signal leading in phase is selected as the triggering signal source.

If this process is reversed, the portion to be measured may sometimes not appear on the screen. Thereafter, equalize the amplitudes of the two signals appearing on the screen or superimpose one on another.

Read the time difference by the interval between 50% amplitude points of the two signals.

Sometimes the superimposing method is more convenient from the point of view of procedure.

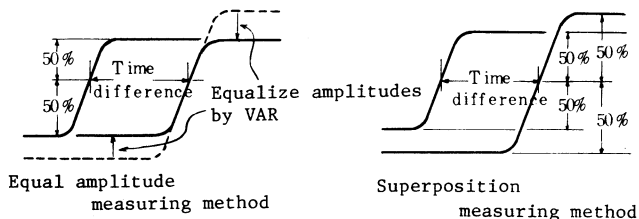

《Cautions》

Since the pulsed wave contains many high-frequency wave components (higher harmonics) depending on its width or period, pay the same attention as given to high frequency signals when handling it. Accordingly, use a probe or coaxial cable and shorten the earth lead wire as much as possible.

(5) Measurement of rise (fall) time

To measure the rise time pay attention not only to the abovementioned items but also to measurement error.

The following relationship exists between the rise time T_{rx} of the waveform to be measured, the rise time T_{rs} of oscilloscope, and the rise time T_{ro} displayed on the screen.

$$T_{rx}^2 + T_{rs}^2 = T_{ro}^2$$

When the rise time of the pulse going to be measured is sufficiently longer than the rise time of the oscilloscope (approx. 6ns in our case), the effect of the rise time of the oscilloscope on the measurement can be neglected. However, if both are close to each other, measurement error may be caused.

The true rise time is given by

$$\text{Trx} = \sqrt{\text{Tro}^2 - \text{Trs}^2}$$

Moreover, in general, in a circuit free from waveform distortion such as overshoot and sag, the following relationship is established between frequency band and rise time.

$$f_c \times t_r = 0.35$$

where, f_c : Frequency band (Hz)

t_r : Rise time (S)

The rise time and fall time are determined by the time elapsed between the 10% to 90% values of pulse width.

This oscilloscope is provided with graduations for 0%, 10%, 90%, and 100% on the screen, which facilitate measurement.

(6) Measurement of single-shot signal

Single sweep is conveniently used in the measurement and photography of single-shot signal, waveform of remarkably non-uniform repetition (such as impulse waves, sound waves, switch noise waves).

First set A TRIG MODE on the front panel to

NORM and the effect synchronization by using a signal or repetitive waveform of about the same level and by rotating LEVEL.

Nest, set A TRIG MODE to SINGLE and depress RESET button to insure that sweep is made one and only one time.

Then remove the vertical axis input signal (by, for example, setting AC-GND-DC switch to GND), depress SINGLE RESET and insure that READY lamp goes on.

Apply the input signal. Sweep is made for one time and Ready lamp goes out. Since sweep is also made at no signal time depending on the level, do not rotate LEVEL once SINGLE RESET is completed.

(7) Synchronization of complexed waveform

In the case shown in the Fig. (a) below where two waveforms greatly different in amplitude alternate, the waveform is doubled if the trigger

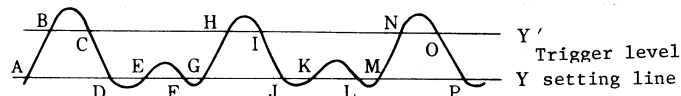

(a) Signal waveform

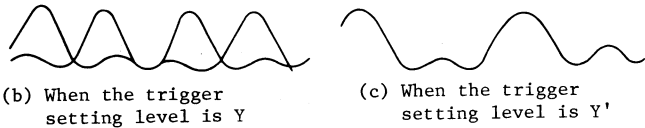

Synchronization of Completed wave form

level is not set properly. In the case where the trigger level is selected as Y line two waveforms, one starting with A and advancing to B, C, D, E, F, and the other starting with E and advancing to F, G, H, I, , will appear alternately on the screen. They will be doubled as shown in Fig. (b), for which no synchronization can be taken.

In such a case, rotate LEVEL clockwise until the trigger level comes to Y' line. Then the waveform on the screen becomes the one is shown in Fig. (c) above which start with B and advances to C, E, F, and which allows synchronization.

(8) How to use TV exclusive synchronization

- ① On the image waveform of TV

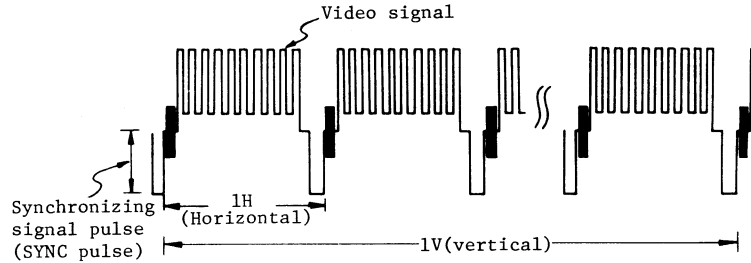

In the work concerned with TV, complexed signals containing video signal, blanking pedestal signal, and synchronizing signal are often measured. However, since the waveform is complexed, a special circuit is needed to effect a stable synchronization with vertical waveform.

② Difference in the circuits

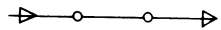
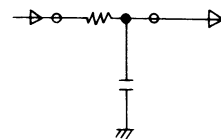
		Exclusive circuit for conventional oscillograph	Exclusive circuit for this instrument (Principle drawing)
		General circuit	Simple synchronizing circuit
Circuit	Video signal		
		<p>To trigger circuit</p> 	<p>To trigger circuit</p> 
	<p>Hard to synchronize, because video signal is applied directly as trigger signal.</p>	<p>Synchronization is more easily effected than in the circuit shown at left, because the signal is integrated to remove high frequency components.</p>	<p>Stable synchronization is obtained since SYNC pulse is picked up, amplified, and then integrated to remove high frequency components.</p>

③ Operation

To observe vertical signal to observe horizontal signal

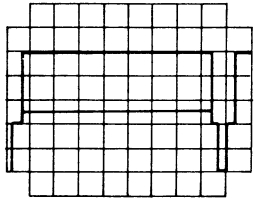

A·TRIG MODE:TV-V

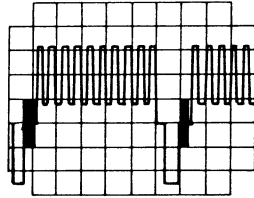

A·TRIG MODE:TV-H

(NOTE) This oscilloscope synchronizes with only (-) synchronizing signal.

(Reference)

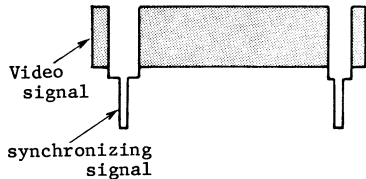

Example of (-) synchronizing signal

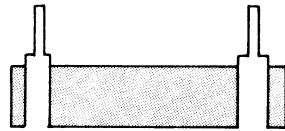

Example of (+) synchronizing signal

(9) Operating procedure of delayed sweep.

(Used to magnify and observe any portion of a complex waveform in horizontal direction.)

There are two kinds of time delay sweep; one is AUTO time delay sweep (continuous time delay sweep) and the other TRIG time delay sweep (triggering time delay sweep). These are selected by MODE switch of B TRIG.

TRIG time delay sweep is further classified into two, the INT (internal triggering time delay sweep) and EXT (external triggering time delay sweep). Usually, the instrument is used in AUTO mode. Although the AUTO time delay sweep is easy to operate the maximum magnification factor is limited the other hand, since no jitter is generated in TRIG time delay sweep, this sweep has the feature of being enabled to increase the magnification factor. However, the magnification factor is limited by the brightness of CRT (to a few thousand times).

- ① At time of AUTO (continuous time delay sweep) Effect triggering by A sweep and set the knobs as follows.

B TRIG MODE AUTO
 DISPLAY INTEN
 A TIME/DIV Choose A TIME/DIV properly
 B TIME/DIV Set B TIME/DIV at a more rapid
 sweep time than the one set by
 A TIME/DIV

Then the high brightness portion of A sweep will appear without fail (if not, adjust INTENS).

Rotate DLY TIME MULT dial. The high brightness portion will move continuously. Bring this high brightness portion to the position desired to be magnified, switch DISPLAY to B. Then the high brightness portion is magnified to occupy the full area of the screen. The sweep time is the indicated value of B TIME/DIV.

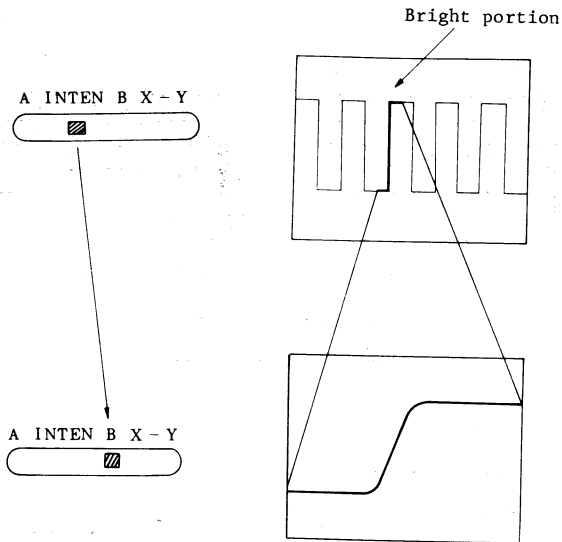

- ② At time of TRIG (TRIGGERING time delay sweep)
 Effect TRIGGERING with A sweep and set the knobs as follows.

B TRIG MODE TRIG (INT or EXT)
 DISPLAY INTEN
 A TIME/DIV Chose A TIME/DIV properly

B TIME/DIV Set B TIME/DIV at a more rapid sweep time than the one set by A TIME/DIV

SLOPE Set SLOPE either to + or to -.

Thereafter, rotate LEVEL. The high brightness portion of A sweep will appear without fail. (This state is called the B-TRIGGERED state.)

Rotate DLY TIME MULT dial. The high brightness portion will move continuously. Further rotation will bring this portion to the next "peak". Therefore, bring this high bright portion to a position desired to be magnified and then set DISPLAY at B.

The high brightness portion is magnified to occupy the full area of the screen. The sweep time for this case is the value indicated by B TIME/DIV. The gen-locking is fixed at AC.

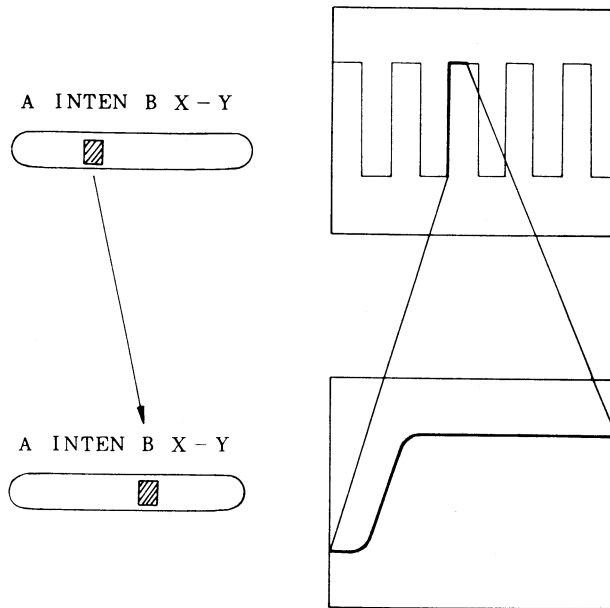

* The case in which SLOPE is + is shown

③ Magnification of TV signal
 Model V-650F has the following three methods to select
 and display the magnified image of any line of TV signal.

Method Setting	Using external trigger (1)	Using external trigger (2)	Using internal trigger
A TIME/DI	5 ms/div (2 ms/div)	Same as left.	Same as left.
A TRIG INPUT	Apply V synchronizing signal	Apply composite video signal or composite synchronizing signal (negative).	Not needed.
A TRIG SOURCE	EXT	EXT	CH1 or CH2
A TRIG MODE	AUTO or NORM	TV-V	Same as left.
A TRIG HOLD OFF	Adjust until the doubled image of fields 1 and 2 dis- appear	Same as left.	Same as left.
A TRIG LEVEL (SLOPE)	Adjust corresponding to V synchronizing signal	No operation is needed.	No operation is needed.
B TIME/DIV	10 μ s/DIV	Same as left.	Same as left.
B TRIG MODE	EXT TRIG (NOTE1)	INT (NOTES 1 and 2)	INT (NOTES 1 and 2)
B TRIG IN	H synchronizing signal	Not needed.	Not needed.
B TRIG LEVEL (SLOPE)	Adjust until the magnified portion in display	No operation is needed.	No operation is needed.
DISPLAY	After setting with INTEN the position to be magnified, set DISPLAY to B	Same as left.	Same as left.
DLY TIME MULT	Set the desired magnification position	Same as left.	Same as left.

(NOTE 1) AUTO is also possible. Although B TRIG needs no
in this case, jitter will appear.

(NOTE 2) The separated H synchronizing signal is applied to
B synchronizing circuit.

With a conventional time delay sweep oscilloscope only the method of "Using external trigger (1)" can be applicable. (In many cases this cannot be applicable.)

In Model V-650F the methods "Using external trigger (2)" and "Using internal trigger" can be done besides the one mentioned above.

This makes Model V-650F very easy to operate.

(10) How to use TRIPLE

- Vertical MODE ALT or CHOP
- TRIPLE PUSH
- A TRIG SOURCE EXT
- A TRIG MODE AUTO



Adjust A TRIG LEVEL. Then three synchronized waves can be observed.

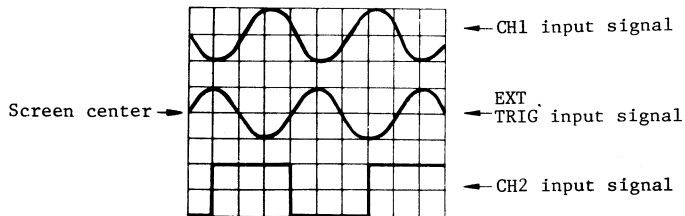

Rotate A TRG LEVEL clockwise. The EXT TRIG input signal on the screen moves downward (↓). Rotate A TRIG LEVEL counterclockwise. Then the input signal moves upward (↑).

Since at this time the TRIGGERING point is near the center of the screen, A TRIG LEVEL must be adjusted to bring EXT TRIG input signal near the center of the screen in order to effect triggering. If it shifts from the neighborhood the center, no triggering will be effected.

(NOTE) In some cases the waveform of trigger signal moves slightly when operating POSITION knob of CH1 and CH2. This movement will also be made when switching TRIG COUPLING from AC to DC or vice versa.

8. Panel Descriptions

(1) Power Supply and CRT

Operating voltage and fuse

This model can be operated from either a 100 volt, a 120-volt, a 220-volt or a 240-volt nominal line voltage source.

The Line Voltage Selector assembly on the rear panel converts the instrument from one operating range to the other. In addition, this assembly changes the primary connections of the power transformer to allow selection of one of four regulating ranges. The assembly also includes the line fuse. Use the following procedure to convert this instrument between nominal line voltages or regulating ranges.

1. Disconnect the instrument from the power source.

2. To convert from 100-volts nominal to 200-volts nominal line voltage or vice versa, pull out the Voltage Selector switch turn it,

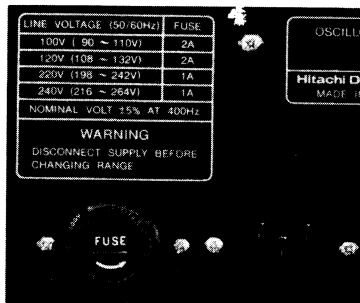

and plug it back into the remaining holes.

Change the line-cord power plug to match the power-source receptacle.

3. Before apply power to the instrument, check that the indicating tabs on the rear panel.

POWER ON
INTENSITY

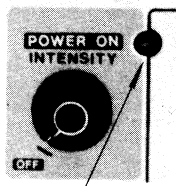

Power on indicat-
ing lamp

After checking the line voltage rotate POWER ON INTENSITY knob counterclockwise to the full to obtain POWER OFF state and then connect the AC cord to AC wall socket. This knob also works as the brightness adjusting variable resistor. Brightness is increased by rotating INTENSITY clockwise.

Indicating
lamp

This lamp goes on in red when the power supply is in ON state.

FOCUS

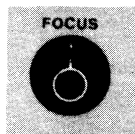

After obtaining an appropriate brightness by operating INTENSITY, adjust FOCUS until the bright line is clearest. Although the focus is also corrected automatically

TRACE
ROTATION



when INTEN is rotated, the focus is sometimes slightly shifted.

Used to correct the slight shift of horizontal bright line from horizontal scale caused by the effect of earth magnetism, etc.

SCALE ILLUM

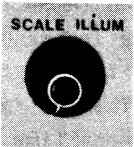

Used to illuminate the screen.

The brightness is increased by rotating this knob clockwise. This lamp is used when using the instrument in a dark place or when taking photographs.

(2) Controls concerned with vertical axis

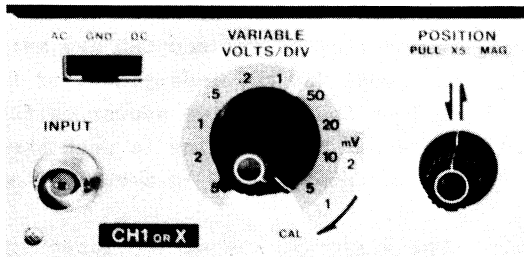

CH1 INPUT BNC connector for vertical axis input. The signal input to this terminal becomes the X-axis signal when the instrument is used as an X-Y oscilloscope.

CH2 INPUT The same as CH1, but when the instrument is used as an X-Y oscilloscope, the signal input to this terminal becomes the Y-axis signal.

AC-GND-DC The switches used to select the coupling system between the input signal and vertical axis amplifier.

AC At this setting the signal is connected through a condenser. The DC component of the input signal is cut off and only the AC component is displayed.

GND At this setting the input to the vertical axis amplifier is grounded.

DC At this setting the input signal is directly connected to the vertical axis amplifier and displayed unchanged, including the DC component.

VOLTS/DIV A step attenuator which selects vertical deflection sensitivity. Set it to an easily observable range corresponding to the amplitude of the input signal.

Multiply the reading by 10 when the 10:1 probe is used in combination with the instrument.

VARIABLE

Fine turning device used to vary the vertical deflection sensitivity continuously. Attenuation of less than 1/2.5 is obtained when this device is rotated in the reverse direction of the arrow to the full.

This control is used when comparing waveforms or when measuring the rise time of a square wave in 2-channel observation. Normally this control is left rotated in the direction of the arrow to the full.

POSITION

The knob used to adjusting the position of the vertical axis.

The image rises with the clockwise rotation of this knob and falls with the counterclock rotation. When the knob is at PULL position (pulled up state) the gain of the vertical axis is magnified 5 times and the maximum sensitivity becomes 1 mV/DIV.

MODE

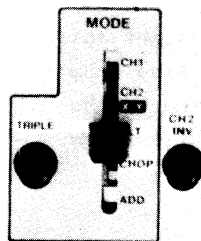

This switch is used to select the operation made of the vertical axis.

CH1 Only the signal that has been applied to CH1 appears on the screen.



CH2 Only the signal that has been applied to CH2 appears on the screen.

ALT Signals applied respectively to CH1 and CH2 appear on the screen alternatively at each sweep. This setting is used the sweep time is short in 2-channel observation.

CHOP At this setting the input signals applied respecting to CH1 and CH2 are switched at about 250 kHz independent of the sweep and at the same time appear on the screen. This setting is used when the sweep time is long in 2-channel observation.

ADD The algebraic sum of the input signals applied respectively to CH1 and CH2 appears on the screen.

CH2
INV

This pushbutton switch is used to inverse the polarity of the input signal applied to CH2. Inversion occurs in a state where the knob of the pushbutton is depressed () and restored to normal when the knob is in protruded state (). This switch is conveniently used in the comparison of two waveforms having different polarity or in the observation of the waveform of the difference signal [CH1]-[CH2] between CH1 and CH2 using ADD.

TRIPLE This switch is used when desiring to observe the waveform triggering signal on the screen. It is also used when measuring the phase difference between the synchronizing signal and other input signal. (Triple phenomena observation.) This switch can be used only when MODE is ALT or CHOP.

(3) Controls concerned with horizontal axis

DISPLAY



This switch is used to select the operation mode of the horizontal axis.

A A sweep appears on the screen. This setting is used in normal cases.

INTEN Although the sweep on the screen is A sweep it indicates B sweep (delay time sweep) by intensity modulation.

B The intensity modulated portion in INTEN mentioned above is magnified to occupy the full area of the screen. The sweep time at this time is B.

X-Y This position is used when using the instrument as an X-Y oscilloscope. X direction signal is input to CH1 and Y direction signal to CH2. The vertical deflection sensitivity at this time is read on CH2 VOLTS/DIV and horizontal axis sensitivity on CH1 VOLTS/DIV. Vertical position is set by CH2 POSITION and horizontal position by \vec{x} POSITION.

A TIME/DIV
B TIME/DIV

B)-A TIME/DIV

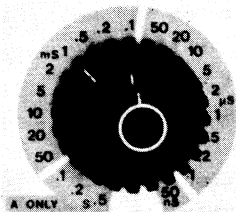

PULL SWP VAR

PULL SWP VAR
VAR HOLD OFF



Those controls are used to set A and B sweep time. The outer knob is used for setting A sweep time and the inner knob for B sweep time. Those two knobs can be rotated independently to facilitate their use. A sweep time ranges from 50 ns/DIV to 0.5 s/DIV (22 steps) and B sweep time from 50 ns/DIV to 50 ms/DIV (19 steps).

In the state where the inner shaft is depressed, this control works as CAL and the sweep time is calibrated to the value indicated by TIME/DIV. TIME/DIV of A sweep can be varied continuously when the inner shaft is at PULL (pulled up state).

Then the control is rotated in the direction of arrow to the full, the CAL state is produced and the sweep time is calibrated to the value indicated by TIME/DIV. Counterclockwise rotation to the full

VAL HOLD OFF

delays the sweep by 2.5 times or more. Normally, the inner shaft is left depressed.

When triggering is hard to be effected caused by complexed signal, high-frequency signal, and irregular signal, rotate this knob slightly to obtain a stabilized triggering. In normal cases, leave this knob rotated counterclockwise to the full.

FINE
PULL $\times 10$ MAG
POSITION

FINE
PULL $\times 10$ MAG
POSITION



This knob is used to move the bright line in horizontal directions.

It is indispensable in the measurement of the time of waveform.

Bright line is moved toward right when the knob is rotated clockwise and toward left with counterclockwise rotation. The outer shaft is for coarse adjustment and the inner shaft for fine adjustment.

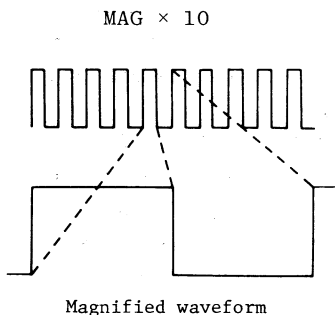

A and B sweeps are magnified 10 times by pulling out FINE knob (inner shaft) of POSITION. In this case the sweep time is 1/10 of the value indicated by TIME/DIV. Bring the portion of the waveform desired to be magnified observed to the outer of the scale by operating POSITION of the horizontal axis. Nest switch $\times 10$ MAG

switch to PULL (pulled out state). Then the waveform placed at the center is magnified in right and left directions. The sweep time in this case is 10 times the sweep speed obtained by TIME/DIV, in other words, the reading is 1/10 of the sweep time indicated.

DLY TIME MULT

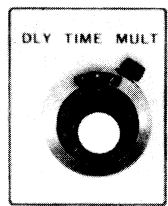

This control is used to set the delay time of B sweep starting point with respect to A sweep starting point. When the above mentioned DISPLAY is set in INTEN or B.

(4) A Synchronization

SOURCE

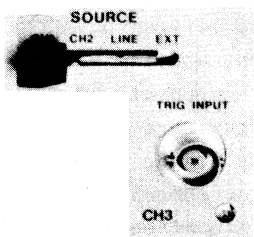

This switch is used to select the triggering signal source A sweep.

CH1 The input signal applied to CH1 becomes the triggering signal.

CH2 The input signal applied to CH2 becomes the triggering signal.

LINE This setting is used when observing a signal triggering with power supply line frequency.

EXT

External triggering signal applied to TRIG INPUT becomes the triggering signal.

This setting is used when triggering with a special independently of the vertical axis signal.

TRIG INPUT

Input terminal for use for external triggering signal of A sweep.

COUPLING



This switch is used to select the coupling mode of A sweep triggering signal.

AC At this setting both the DC component and the very low frequency components of triggering, signal are cut off.

LF REJ Among the AC components of the triggering signal the low frequency components of less than about 4 kHz are attenuated. A stabilized triggering free from noises of less than about 4kHz can be obtained.

HF REJ Among the AC components of triggering signal, the high frequency components of about 4 kHz or more are attenuated. A stabilized triggering unaffected by noises of about 4 kHz or more can be obtained.

DC Triggering signal is amplified unchanged. This setting is used when triggering with a very low frequency signal or when effecting DC like triggering.

A TRIG LEVEL This knob is used to decide at which portion of the waveform should the sweep be started by setting trigger level. This knob is also enabled to switch SLOPE. Depressed position (normal state) is for \oplus SLOPE and PULL position (state in which the knob is protruding) is for \ominus SLOPE.

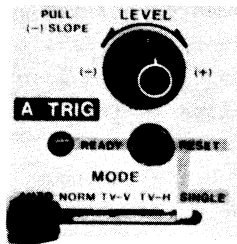

* Explanation of synchronization polarity SLOPE.

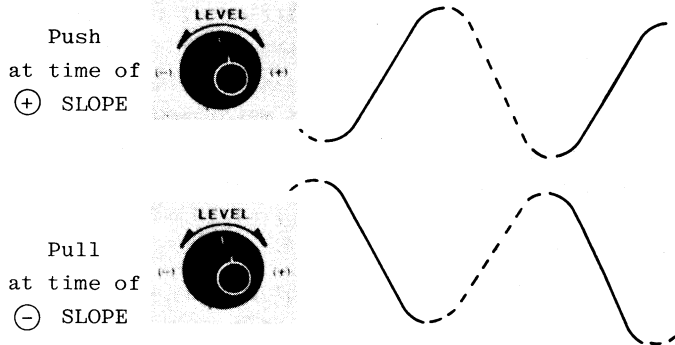

※ Explanation of synchronization level LEVEL.

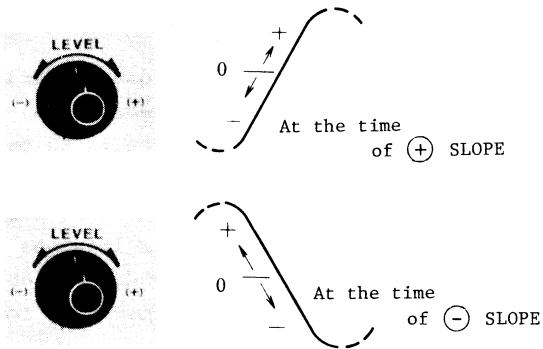

A TRIG MODE AUTO The instrument is brought into automatically triggering sweep in which sweep is always conducted. In the presence of triggered signal, normal triggered sweep is obtained and the waveform stands still. In the case of no signal or out of triggering, sweep line will appear automatically. This setting is convenient in usual cases.

NORM Triggered sweep is obtained and sweep is conducted only when triggering is effected. No sweep line will appear

TV(V) in the case of no signal or out of synchronization. Use this MODE when effecting synchronization to a very low frequency signal (30 Hz or less). This setting is used when observing the entire vertical picture of television signal.

TV(H) This setting is used when observing the entire horizontal picture of television signal.

(NOTE) Both TV.V and TV.H synchronize only when the synchronizing signal is negative.

SINGLE Conducts sweep for one time by trigger signal.

READY At time of SINGLE, this lamp is lit to show the instrument is ready for single sweep. The lamp goes out when the sweep is started.

RESET At time of SINGLE, the READY lamp goes on by depressing this switch.

(5) B Synchronization

B TRIG INPUT Input terminal for external triggering signal for B sweep. Use it after setting B TRIG MODE to EXT.

B TRIG MODE AUTO B sweep is automatically started after elapsing the delay time determined by A sweep and DLY TIME POSITION.

Usually, the instrument is used at this setting.

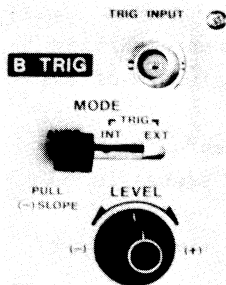

TRIG INT Trigger signal is selected by a TRIG SOURCE. Moreover, A TRIG MODE is automatically switched to NORM from TV-H and to TV-H from TV-V.

TRIG EXT For external triggering. Synchronization is effected by applying the input signal itself or other signal which is integer times of input signal in time. Triggering coupling is AC fixed.

This setting is used when performing delay time sweep magnification by removing jitters.

B TRIG LEVEL This knob is used to determine the portion of the trigger signal of B sweep where the sweep is to be started. This knob has no relationship when B TRIG MODE is set at AUTO. Switching of slope is made simultaneously by this knob. Depressed position is for \oplus SLOPE and PULL position for \ominus SLOPE.

(6) Miscellaneous

EXT BLANKING Input terminal for brightness modulation. It is of the DC coupling. The brightness is reduced with a positive signal and increases with a negative signal.

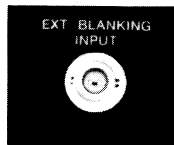

CAL 0.5V



Output terminal of calibration square wave of about 1kHz and 0.5V. It has a tip terminal. It is used to calibrate the probe combination.

CH1 OUTPUT

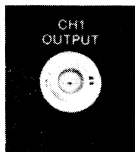

Output connector providing a sample of the signal applied to the CH1 input connector. This connector operate for driving a frequency counter or other instrument.

If the output offset level is shifted (more than ± 2 division), readjust the DC Balance of CH1(RV27) and Trigger level of CH1(RV64).

GND

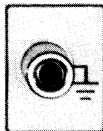

Earth terminal of the oscilloscope.

9. Standards and Specifications

o Vertical axis

Input sensitivity $\times 1$ 5mV/div-5V/div (1,2,5-step 10 stage selection)

$\times 5$ 1mV/div-1V/div (1,2,5-step 10 stage selection)

Sensitivity $\times 1 \pm 3\%$ (10~35°C), $\pm 5\%$ (0~50°C)

accuracy rate $\times 5 \pm 5\%$ (10~35°C), $\pm 7\%$ (0~50°C)

Attenuates continuously to 2.5 times or more of the indicated value in each range

Frequency band

$\times 1$ 10mV/div-5V/div

DC~60MHz $\left(\begin{matrix} +1 \\ -3 \end{matrix} \text{dB} \right)$

AC 10Hz-60MHz $\left(\begin{matrix} +1 \\ -3 \end{matrix} \text{dB} \right)$

5mV/div

DC~55MHz $\left(\begin{matrix} +1 \\ -3 \end{matrix} \text{dB} \right)$

AC 10Hz-55MHz $\left(\begin{matrix} +1 \\ -3 \end{matrix} \text{dB} \right)$

$\times 5$ DC to 10MHz $\left(\begin{matrix} +1 \\ -3 \end{matrix} \text{dB} \right)$

AC 10Hz to 10MHz $\left(\begin{matrix} +1 \\ -3 \end{matrix} \text{dB} \right)$

Rise time

Approximately less than 7ns

Signal delay time

Possible to observe the rising edge

Input impedance

Direct $1\text{M}\Omega \pm 1.5\%$, $30\text{pF} \pm 3\text{pF}$

When AT-10AD1.5 type is used

$10\text{M}\Omega$, approximately 12pF

Maximum Input voltage	Direct 250V(DC+AC peak at 1 kHz) When using $\times 10$ probe 500V(DC + AC peak at 1kHz)
Input coupling	AC-GND-DC
Magnifying function	$\times 5$ is possible
Operation mode	CH1, CH2, ALT, CHOP (switching frequency; approximately 250 kHz) ADD (DIFF is possible at CH2 INV)
Polarity switching	Possible only in CH2
Triple function	Difference between trigger signal and trigger level signal is displayed on the screen at time of ALT, CHOP.
Sensitivity	INT: $1/1 \pm 30\%$ of screen area EXT: $0.2 \text{ V/div} \pm 30\%$
Frequency band	EXT: DC to 50 MHz (-3dB)
Position	Screen center ± 2 div (trigger level knob is set at the center)
Bright line position adjustment	Adjustable within the screen area

CH1 Output	
Output voltage*	25mV/div $\pm 20\%$
Bandwidth*	DC-20MHz (-3dB) (at $\times 1$ GAIN)
Output Offset Voltage*	$\pm 50\text{mV}$ (20-30°C) $\pm 100\text{mV}$ (0-40°C)
Output Noise*	10mVp-p Max.
	*Measured by 1m 50-ohm BNC cable with 50-ohm terminator.
Output impedance	Approx. 50 Ω
Output coupling	DC
o Horizontal axis	
Sweep mode	A, INTEN, B, X-Y
A sweep time	50ns/div-0.5s/div(1-,2-,5-step 22 stages)
B sweep time	50ns/div-50ms/div(1-,2-,5-step 19 stages)
Maximum sweep time	5ns(at MAG $\times 10$)
Sweep variable	A ; 2.5 times or more B ; Absent
Sweep time accuracy	$\pm 3\%$ (+10 - +35°C) $\pm 5\%$ (0 - +50°C)
Sweep magnification	$\times 10$ Error ; Sweep time error $\pm 2\%$
Position adjustment	Possible

Calibrated Sweep Delay Continuous calibrated control between 0.5 and 10× time base A setting

Delay jitter 1/20,000 or less

Hold off Variable

o Trigger

Triggering mode A Triggering: AUTO, NORM, TV-V, TV-H, SINGLE
B Triggering; AUTO, TRIG INT, TRIG EXT.

Triggering level For both A and B, Internal; variable range 4div or more.
External; approximately $\pm 2V$

Triggering polarity For both A and B: \pm

Triggering sensitivity and frequency () is only for B

Frequency	Internal	External
DC(30Hz) - 10MHz	0.5 div	150 mV
10 MHz - 50 MHz	1.5 div	500 mV
50 MHz - 60 MHz	2.0 div	600 mV

TV-V sensitivity: SYNC section less than 0.7div or 200mV

AUTO low band : approximately 30Hz

External trigger input impedance For both A and B. $1M\Omega \pm 20\%$, $30pF \pm 6pF$

However, settings HF REJ and LF REJ are not included

Maximum input voltage For both A and B. Direct 250V(DC + AC peak at 1kHz)

At time gasing $\times 10$ probe 500V(DC+AC peak at 1kHz)

o Z-AXIS brightness modulation

Voltage Brightness is reduced with a positive signal of +5V or more

Frequency band DC to 3.5 MHz

Input impedance Approximately 20 k Ω

Maximum Coupling 50 V (DC + AC peak)

DC

o X-Y operation

X input ; CH1

Y input ; CH2

Sensitivity; Same as vertical axis

Accuracy ; X; $\pm 5\%$, Y; Same as CH2

X band wise; DC to 500 kHz

Phase difference; Within 3° (DC to 50kHz)

o Calibrator
 Waveform 1kHz square wave, within +5%
 Voltage 0.5V ± 1%
 Rise time 5μs or less

o CRT
 CRT 150 BCB 31 (6", square with
 internal graph)
 Acceleration voltage Approximately 10kV
 Screen area 8 div ×10 div, 1 div = 10 mm
 Brightness Possible
 adjustment
 Focussing Possible (with AUTOMATIC
 focus correction circuit)
 Trace rotation Present
 Scale illumination Variable

o Power supply

VOLTAGE (50/60Hz)	FUSE
100 V (90 - 110 V)	2A
120 V (108 - 132 V)	2A
220 V (198 - 242 V)	1A
240 V (216 - 264 V)	1A

Nominal voltage ± 5% at 400 Hz

Power supply 50, 60, 400Hz
 frequency
 Power consumption Approximately 45W

o Environment
 Operating ambient 0 - 50°C
 temperature
 Operating ambient 35 - 85%
 humidity
 Specification 10 - 35°C
 guaranteed ambient
 temperature
 Specification 45 - 85%
 guaranteed ambient
 humidity

o Construction
 Dimensions Approximately 310(W) × 180(H)
 ×410(D)(mm) (Dimensions of
 cabinet)
 Weight Approximately 9.3kg

10. Schematic Diagrams

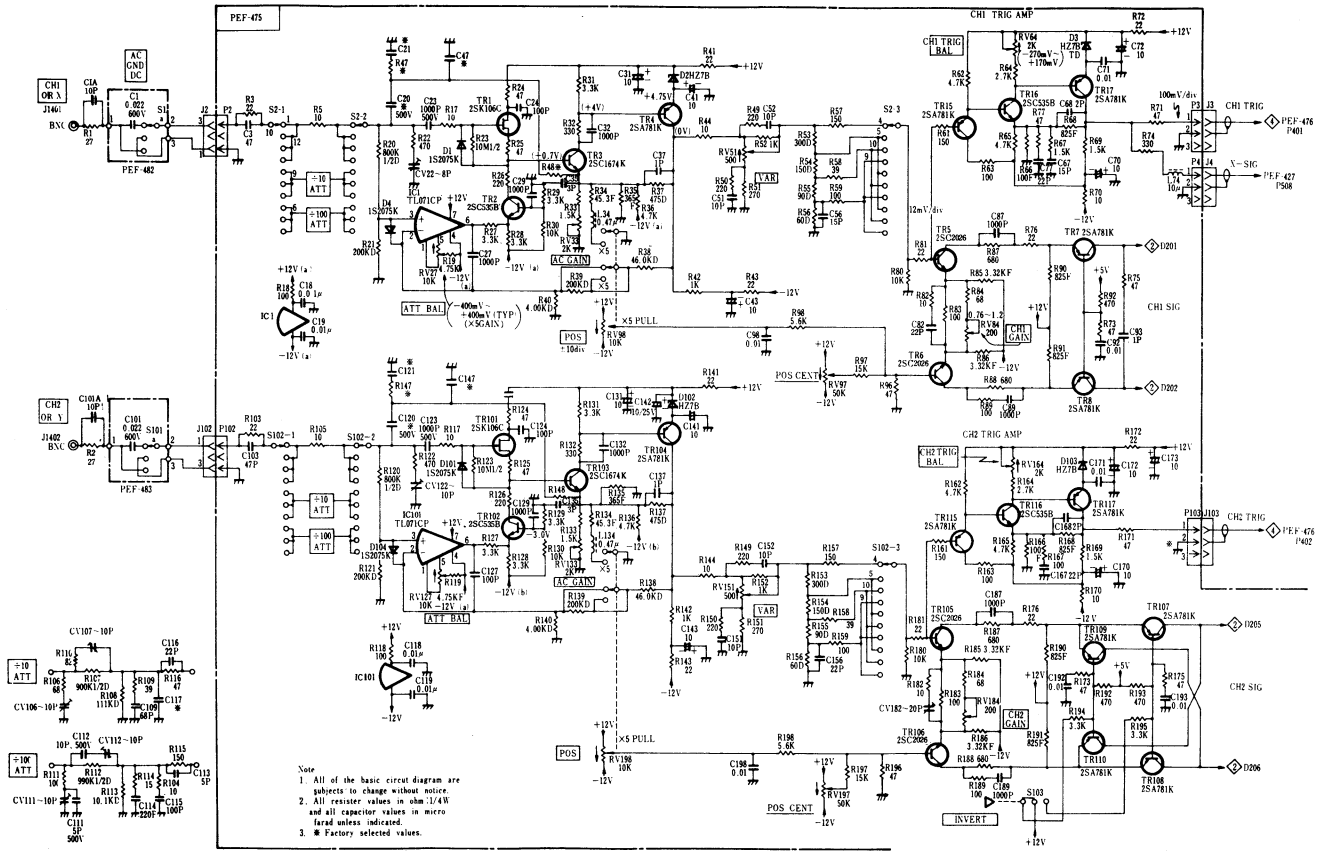

◇ V-650F VERTICAL PREAMPLIFIER

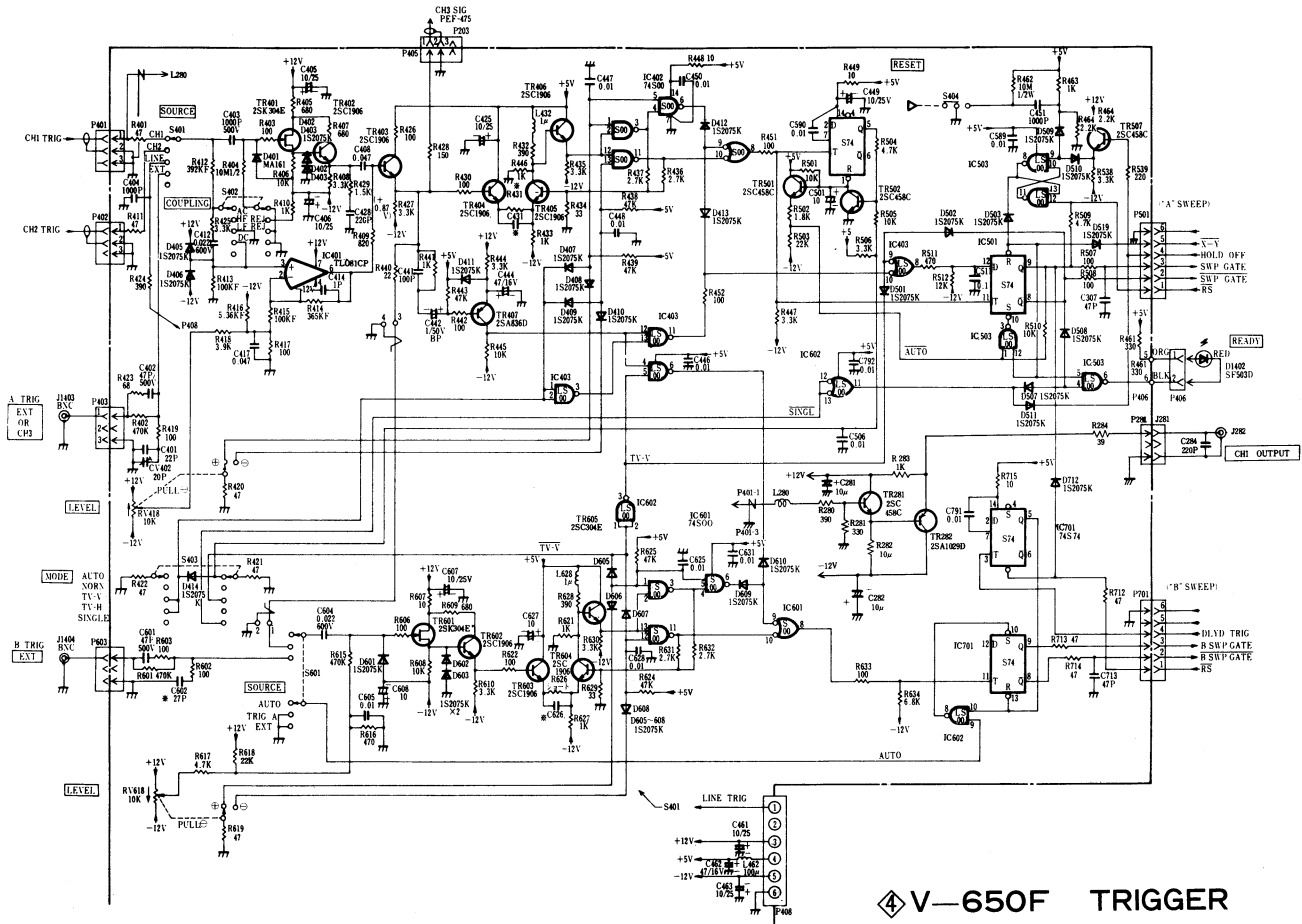

4 V-650F TRIGGER

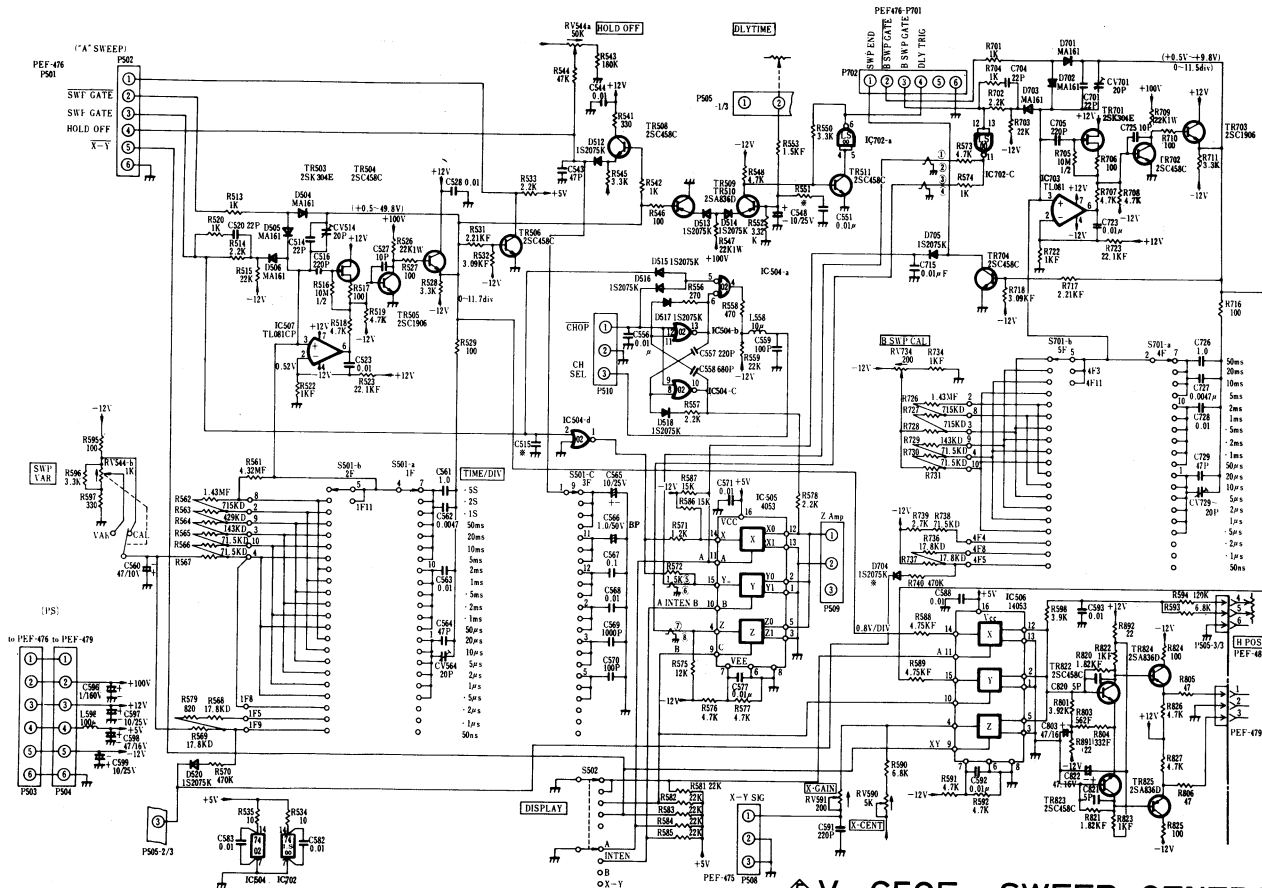

◆ V-650F SWEEP GENERATOR

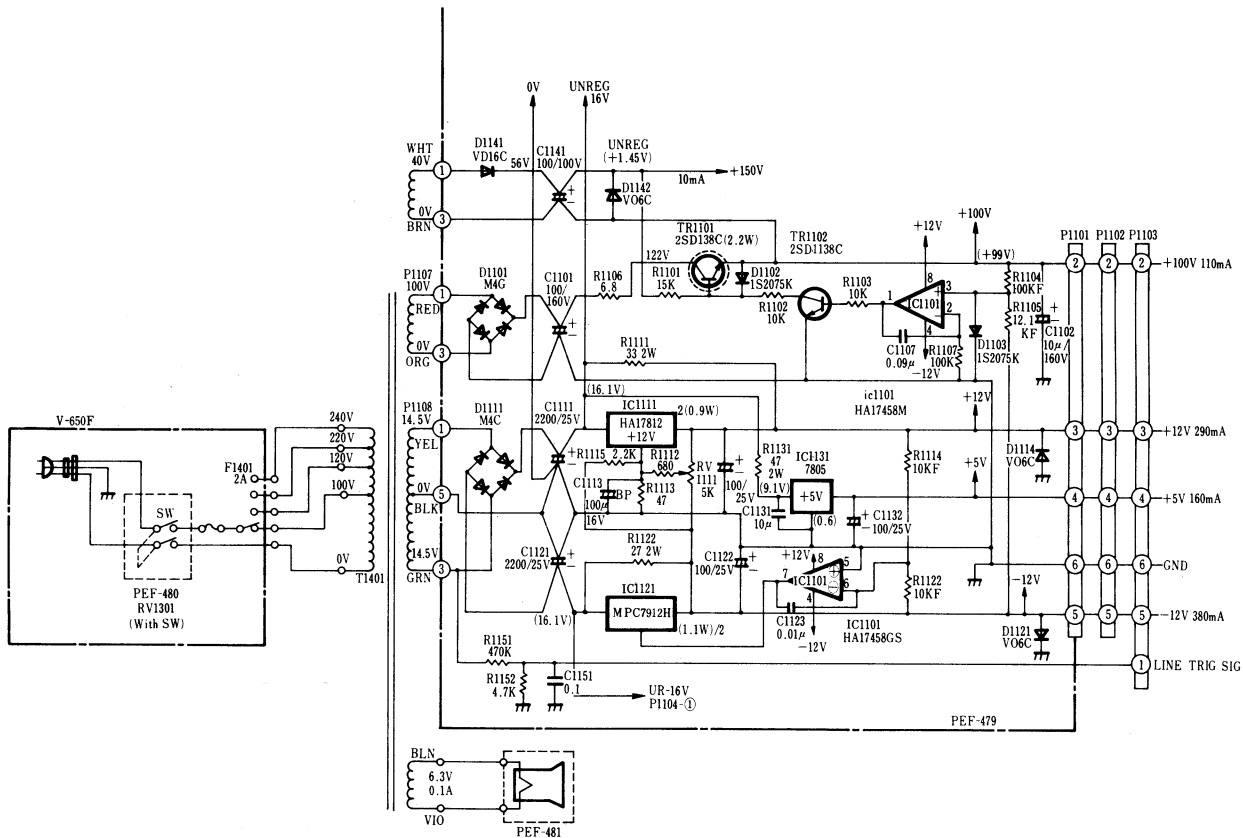

⑥ V-650F POWER SUPPLY

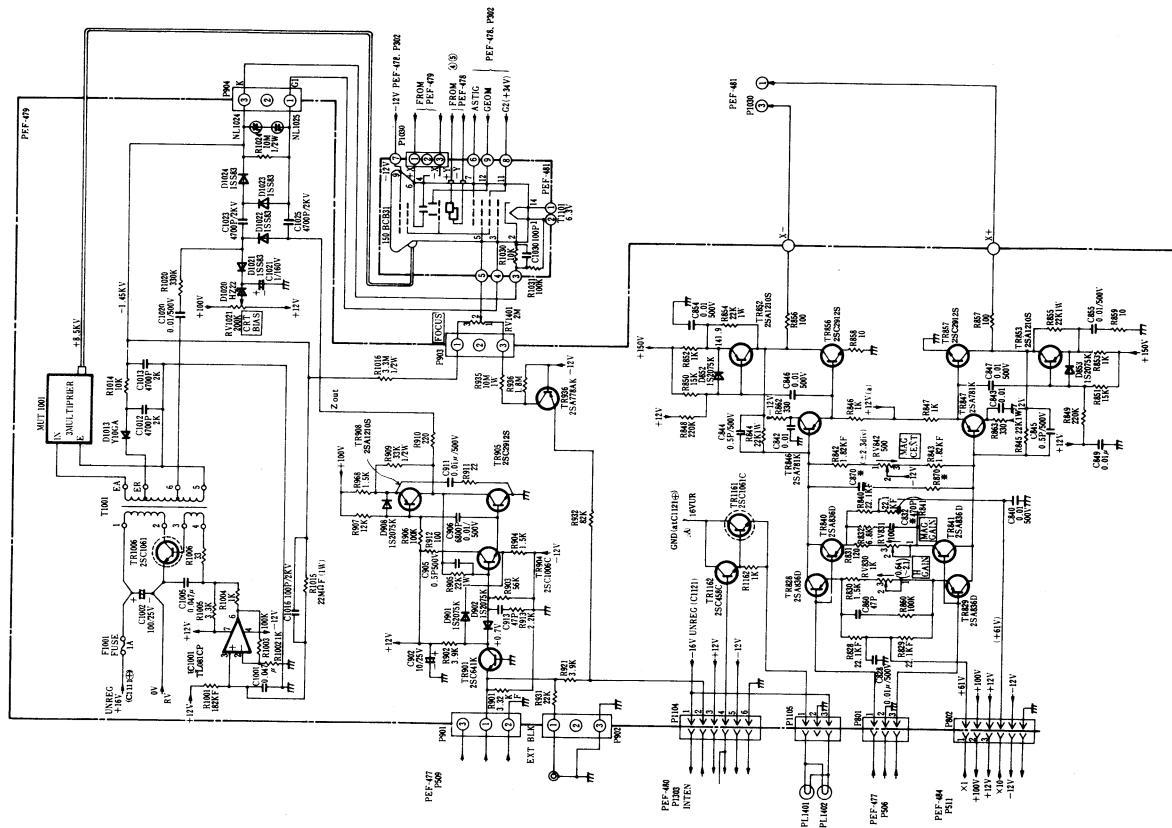

◇ V-650F HIGH VOLTAGE UNIT & Z-AXIS HORIZONTAL AMP

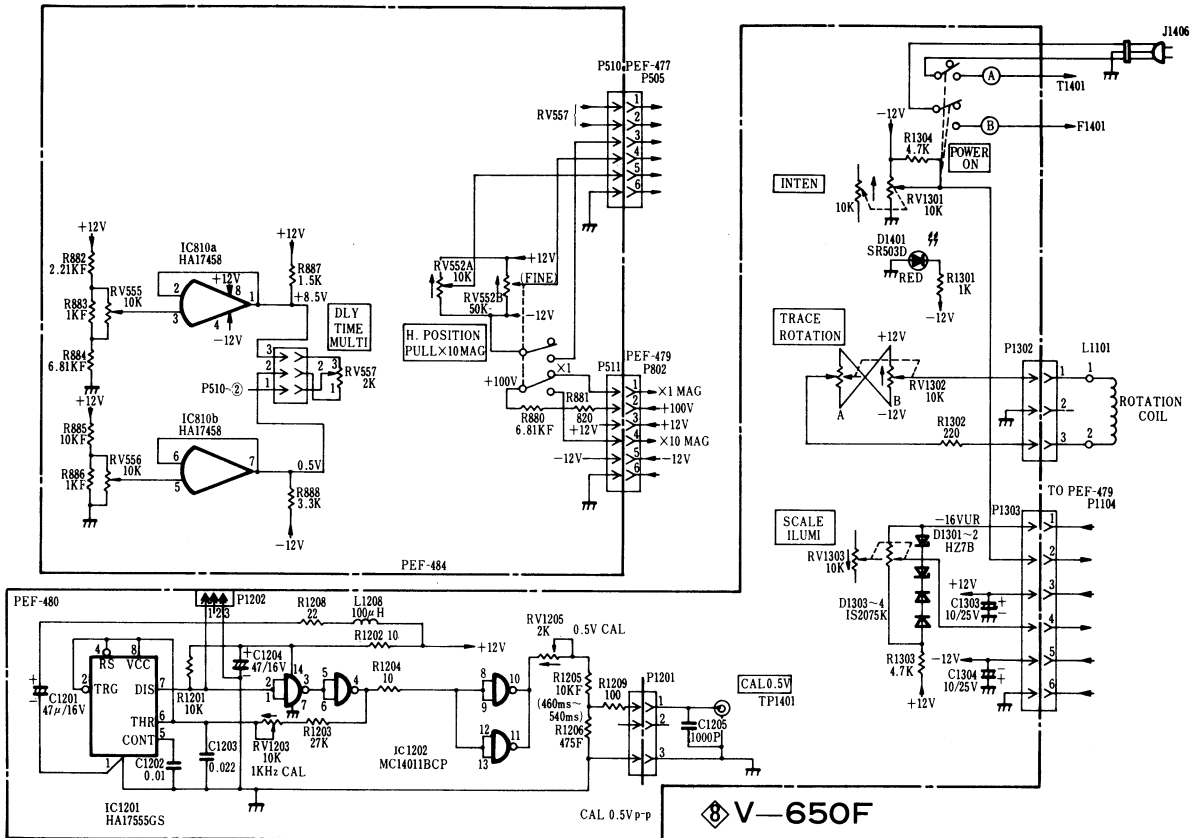

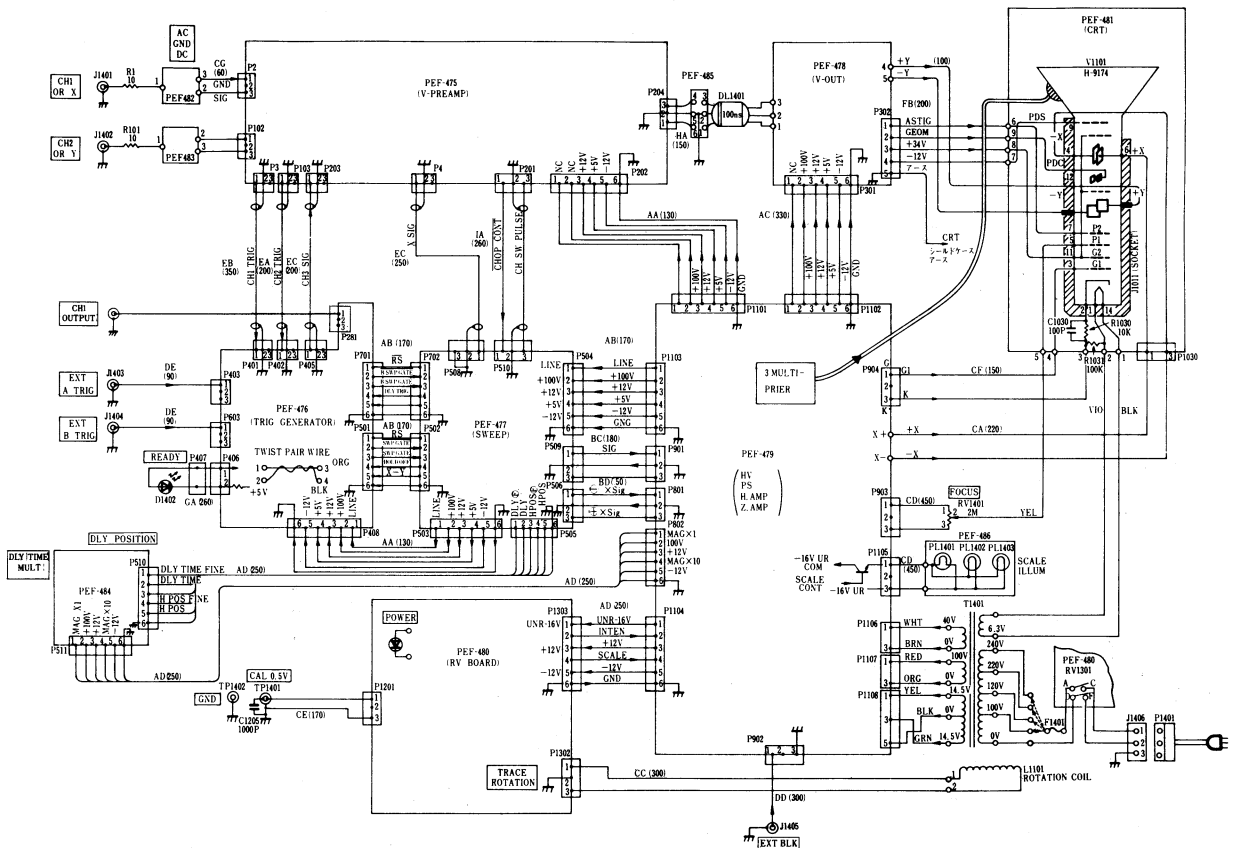

⑨ V-650F WIRE CONNECTION

NOTE

- o This instrument should be adjusted at an ambient temperature of +20°C for best overall accuracy. Allow at least 15 minutes warmup before proceeding.
- o Polyvinyl chloride (PVC) film is attached on the enclosure and the front panel of the oscilloscope to protect the metal surface. If the PVC film is damaged by scratches, remove it.
- o To clean the enclosure or the front panel, use neutral detergent. Refrain from using thinner, benzine, alcohol or other chemicals.
- o For safety operation, the instrument chassis and cabinet be sure to connect the ground lead of the GND (ground) terminal to earth ground, if a two-wire AC power system is used. Failure to complete the ground system may allow the chassis and cabinet of this instrument to be elevated above ground potential and pose a shock hazard.